

Formation 2011

Luminergie

Qui sommes-nous ?

- En affaires depuis 4 ans ;
- Distribué dans 11 pays ;
- 8 divisions :
 - Montréal
 - Toronto
 - Ottawa
 - Vancouver
 - U.S.A ; New York, Los Angeles
 - Nice, France
 - Iraputo, Mexique
 - Singapour ;
- Plus de 300 produits ;
- Plusieurs gammes privées ;
- Plus de 3 millions de dollars en inventaire;
- Une salle de montre à Montréal et en France pour rencontrer les clients, designers, architectes, etc.





Notre Équipe



- Équipe Canadienne :
 - Département du service à la clientèle ;
 - Chargé de projet : soumission, installation et concept ;
 - Représentants sur la route ;
 - Service de conception de projet sur mesure*.
- Équipe en chine :
 - Un bureau à Shangai et un à Shenzen ;
 - Équipe de vente complète de + de 10 personnes ;
 - Contrôle de la qualité fait par un ingénieur canadien.

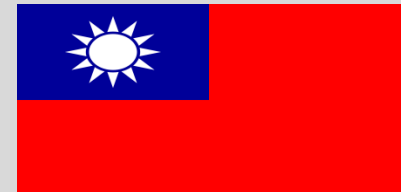



Gamme d'ampoules rétrofit



- Aucune modification nécessaire ;
- DEL de 1^{ère} qualité ;
- Plusieurs modèles dimmable ;
- 12V et 120V offerts ;
- Plusieurs couleurs disponible ;
- Intérieur / extérieur ;
- Garantie concurrentielle.

CREE

EDISON



Légende des ampoules

VOLTAGE



Dimmable
Graduable



Outdoor Usage
Utilisation Extérieure



Indoor Usage
Utilisation Intérieure



COULEURS

CW	BLANC FROID	6000K	Sur commande: 3400-3600 K
WW	BLANC CHAUD	3000K	4100-4300 K
RD	ROUGE	620-630 nm	
YL	JAUNE	588-592 nm	
BL	BLEU	465-470 nm	
GR	VERT	515-520 nm	
PU	VIOLET	400-410 nm	
PK	ROSE	590-600 nm	

ANGLE DE VISION



XSPOT

Faisceau 15°

Plafond de
14' et +



SPOT

Faisceau 30°

Plafond de
10 - 14'



FLOOD

Faisceau 60°

Plafond de
10' <

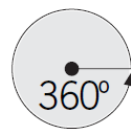

Faisceau 360°

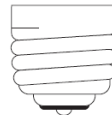

E26

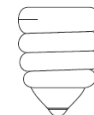

E12



GU10



GU5.3
(MR16)



GU4
(MR11)

Comment commander une ampoule

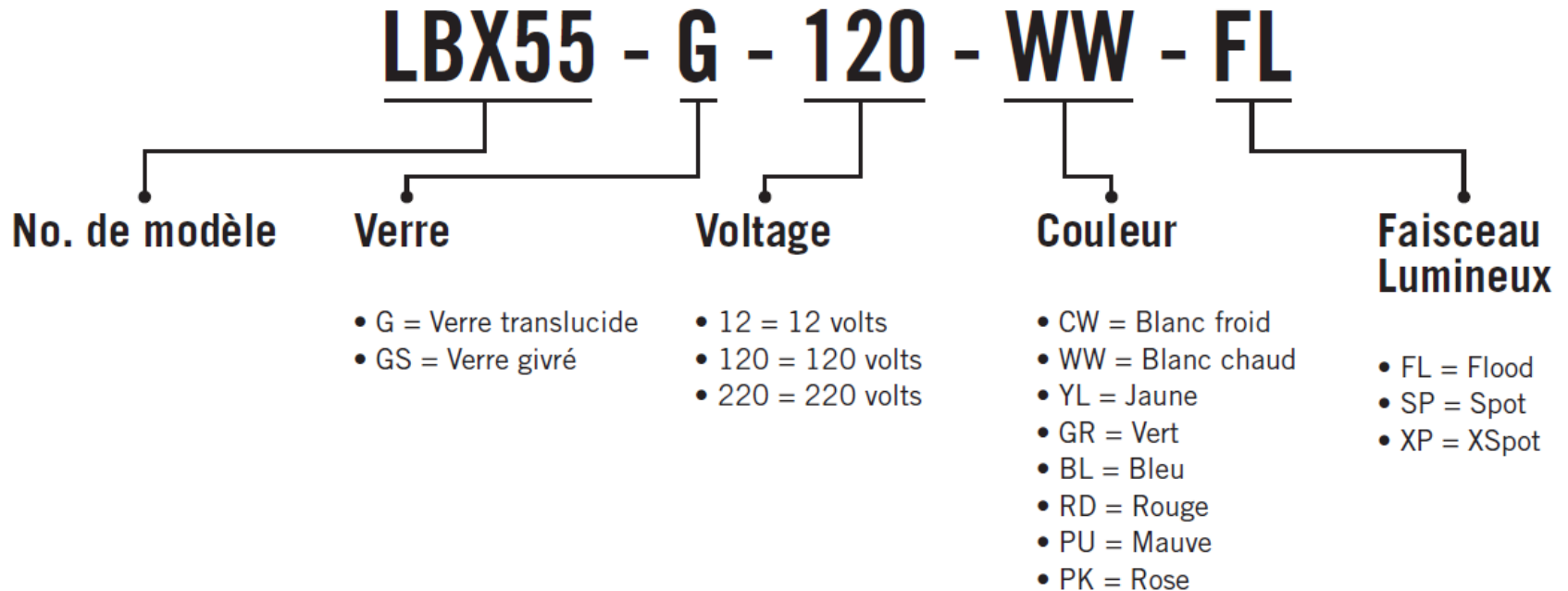

Liste de prix des ampoules

Nom produit	Lumen	Dim / non Dim	Option voltage	Option Couleur	Coûtant	Prix base	Prix affiché
LBX30	337	NON	12 V / 120 V	CW / WW	\$19,96	\$24,95	\$31,19
PAR30HP7W	504	sur demande	120 V	2800K-4200K-5600K	\$47,96	\$59,95	\$74,94
PAR20HP4W	319	OUI	120 V	2800K-4200K-5600K	\$19,96	\$24,95	\$31,19
GU10HP9WXPE	315	OUI	120 V	2800K-4200K-5600K	\$30,36	\$37,95	\$47,44
MR16HP9WXPE	315	OUI	12 V	2800K-4200K-5600K	\$28,76	\$35,95	\$44,94

12V

Ruban lumineux (Strip tape)

24V

- Facile à installer ;
- Ne dégage pas de chaleur ;
- Équipé d'une bande autocollante 3M ;
- Plusieurs intensités et couleurs disponible ;
- Coupé selon vos mesures* sans frais ;
- Prix spéciaux pour roulettes de 5 mètres ;
- Plusieurs transformateurs disponible ;
- Dimmable.



Dimmable
Graduable

Date : _____

PO : _____

Tag / Job : _____

⇐ Télécopieur / Fax: 514 903-0649

BON DE TRAVAIL / WORK FORM

Réservé à l'administration / Reserved for the administration
#PO : _____

Ruban flexible DEL / LED Strip Tape

4.8W		9.6W		19.2W	
<input type="checkbox"/> CW - 5800K	<input type="checkbox"/> BL	<input type="checkbox"/> CW - 5800K	<input type="checkbox"/> CW - 5800K	<input type="checkbox"/> CW - 5800K	<input type="checkbox"/> CW - 5800K
<input type="checkbox"/> NW - 4200K	<input type="checkbox"/> YL	<input type="checkbox"/> NW - 4200K	<input type="checkbox"/> NW - 4200K	<input type="checkbox"/> NW - 4200K	<input type="checkbox"/> NW - 4200K
<input type="checkbox"/> WW - 3000K	<input type="checkbox"/> PK	<input type="checkbox"/> WW - 3000K	<input type="checkbox"/> WW - 3000K	<input type="checkbox"/> WW - 3000K	<input type="checkbox"/> WW - 3000K
<input type="checkbox"/> RD	<input type="checkbox"/> PU				
<input type="checkbox"/> GR	<input type="checkbox"/> AM				

4.4W-SIDE
<input type="checkbox"/> CW - 5800K
<input type="checkbox"/> WW - 3000K
7.7W-SIDE
<input type="checkbox"/> CW - 5800K
<input type="checkbox"/> WW - 3000K

7.2W
<input type="checkbox"/> RGB
14.4W
<input type="checkbox"/> RGB

1. Nombre de ruban(s)
Strip Amount Total : _____

2. Longueur(s) du(des) ruban(s) / Longueur(s) du(des) fil(s)
Strip Length / Wire Length Total : _____

Pouces - Inches Pieds - Feet Mètres - Meters

AUTRES / OTHER

EXEMPLE : 8" 12" 4" 24"

EXAMPLE: 

Transformateur / Power Supply

Quantité / Quantity: _____ Item : _____

Voir la liste complète de transformateur au verso
See our complete Power Supply list on the back

CREE

Type de ruban



ST - 4.8 **12V**



ST - 9.6 **12V**



ST - 19.2 **24V**

CW Cold White
Blanc Froid

NW Neutral White
Blanc Neutre

WW Warm White
Blanc Chaud

RD Red Color
Couleur Rouge

YL Yellow Color
Couleur Jaune

BL Blue Color
Couleur Bleu

 Dimmable
Graduable

GR Green Color
Couleur Verte

PU Purple Color
Couleur Mauve

PK Pink Color
Couleur Rose



CREE

RGB (Red-Green-Blue)



RGB



ST - RGB - 7.2 **12V**



ST - RGB - 14.4 **12V**

RGB



Distributeur exclusif de LTECH

- Leader mondial en équipement de contrôle DMX / 0-10V
- Utilisé par :
 - Cirque du soleil
 - Radio Canada
 - TVA
 - SOLOTECH
 - ZONE 3
 - Et bien d'autres ...



LTECH

4.8 / 9.6 / 19.2 / 7.2 / 14.4

- Le chiffre veut dire le nombre de watt par mètre. Ex : 4.8 = 4.8W/Mètre ;
- Plus le chiffre est gros, plus l'intensité est forte ;
- Vous devez toujours connaître vos mesures voulues en mètre. ex: le client veut 25 po donc il veut : 0,64M ;
- 1 mètre = 39.37 pouces = 3.28 pieds.

Quel transformateur choisir ?

- Vous prenez votre mesure en mètre X l'intensité voulue. Ex : $0.64M \times 4.8 = 3.07 \text{ W}$;
- Cette bande de ruban consomme donc 3.07 watt ;
- Pour optimiser la durée de vie des transformateurs, vous devez les charger à un maximum de 85% ;
- Donc vous devez calculer : $3.07W / 0.85 = 3.61W$;
- Ensuite, trouvez le transformateur disponible qui est capable de supporter 3.61W donc = 6W.

Pour commander un transformateur





PS - CV - 120 - 12 - 500mA - 6W –IP65- PG

Que veut dire le code ?

PS	Power supply (unité de puissance)
CV / CC	Constant Voltage / Constant current
120	Power IN (primaire)
12	Power OUT (secondaire)
500mA	Ampérage
6W	Wattage
PG	Plug (type de branchement)



Type de transformateur disponible

PG	Transformateur plug-in (permet un branchement direct à une prise de courant)	
EN	Transformateur "enclosed" (pour l'intérieur, les fils d'alimentation se vissent directement dessus)	
HW	Transformateur "hard wire" (pour l'extérieur, les fils d'alimentation sont déjà sur le transformateur)	
DK	Transformateur "desktop" (comme un bloc d'alimentation pour portable par exemple)	

Charte transformateur VS ruban

M
è
t
r
e

Transfo	Watts	Type	Watts Max	WW / CW / NW / Couleurs			RGB	
				4,8	9,6	19,2	7,2	14,4
12VDC	6	ENC	5,1	1,06	0,53	-	0,71	0,35
	10	HW	8,5	1,77	0,89		1,18	0,59
	12	PG	10,2	2,13	1,06		1,42	0,71
	20	HW	17	3,54	1,77		2,36	1,18
	24	PG	20,4	4,25	2,13		2,83	1,42
	30	HW	25,5	5,31	2,66		3,54	1,77
	48	DK	40,8	8,50	4,25		5,67	2,83
	60	HW	51	10,63	5,31		7,08	3,54
	75	ENC	63,75	13,28	6,64		8,85	4,43
	150	ENC / HLG	127,5	26,56	13,28		17,71	8,85
	240	ENC	204	42,50	21,25		28,33	14,17
	320	HW	272	56,67	28,33		37,78	18,89
24VDC	10	HW	8,5	-	-	0,44	-	-
	20	HW	17			0,89		
	24	PG	20,4			1,06		
	40	HW	34			1,77		
	48	DK	40,8			2,13		
	60	HW	51			2,66		
	100	HW	85			4,43		
	150	HW	127,5			6,64		
	240	HW	204			10,63		

Gamme décorative

- Leader mondiale en DEL.
- Produits pour l'intérieur et l'extérieur* .
- Garantie concurrentielle.
- Ne dégage pas de chaleur.
- Peut être contrôlé :
 - Constant current
 - DMX
 - 12 VDC
 - 24 VDC
 - 120V ON/OFF
 - 120V DIMB = triac *EVC
 - 120V DIMA = 0 - 10 V

CREE

DÉCO·DEL
PAR **Lum^{nergie}**

Comment commander la série PL200

Couleur disponible : WH (white) ALU (aluminium) BK (black)

PL200-ALU-F4 - SPOT - CW - S4S

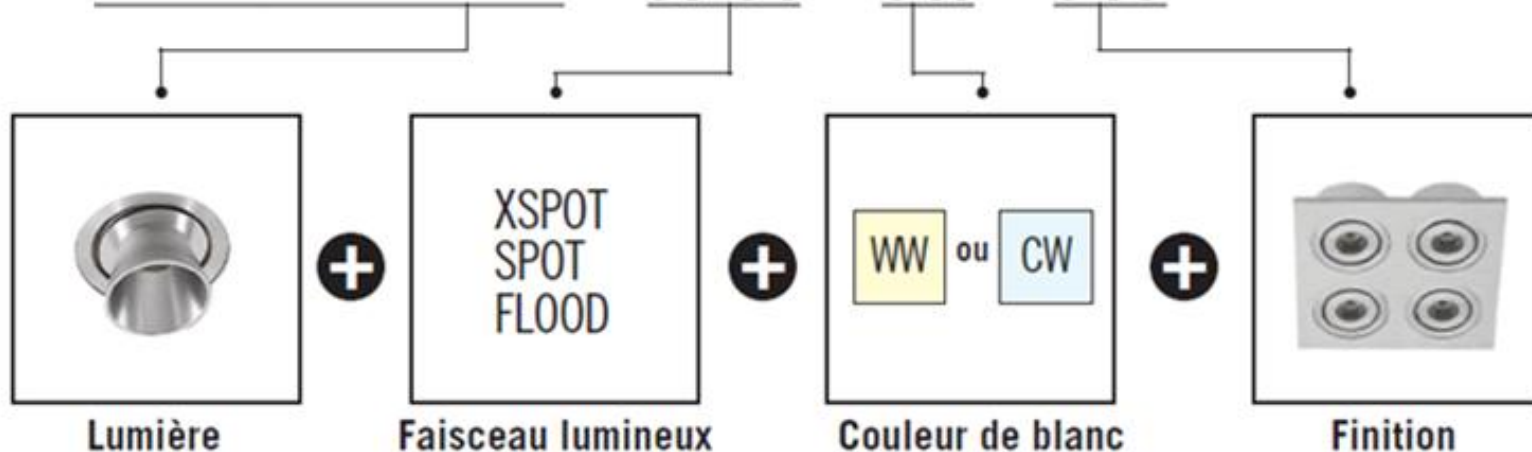

Produit sélectionné
PL200-3W-FL-WW-S4S

Type d'insertion et finitions

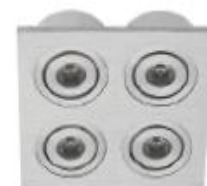
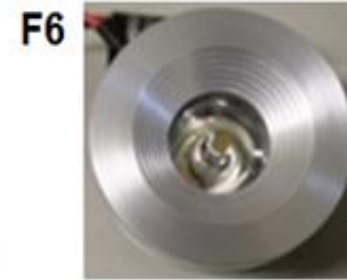

R1

S1

S2

S3

S4

S4S

Constant Current

- Tout les DELs **CREE**t une valeur de 3.2V / CH à 1A (1 ampère)
- Pour prolonger la vie du DEL, nous contrôlons l'ampérage ;
- À 700mA (milliampère) on utilise le produit à 70% de sa capacité. À 350mA, 35% ;
- Donc, un DEL de 3.2V devient :
 - À 700Ma X 3W = 2.1W
 - À 350Ma X 3W = 1.05W

Transformateurs

- Contrairement au ruban lumineux, les encastrés ne fonctionnent pas en 12V mais en courant constant. On ne doit donc pas brancher du 12V / 120V directement ;

Transformateur ampérage constant 700mA AC/DC - DC/DC							max load	Led max load
3W	PS-CC-120-700mA-9W-HW	Ezled Power	LD-CU7021AF	3-21VDC 700mA	N/D	cULus	3	1-4
	PS-CC-120-700mA-18W-HW	Ezled Power	LD018H-CU7026-15	3-26 VDC 700mA	N/D	cULus	6	1-8
	PS-CC-120-700mA-9W-DIMA-EN	Ezled Power	LD-CU7012-04D	3-12 VDC 0-700mA	0-10V	cULus	3	1-4
	PS-CC-120-700mA-16W-DIMB-HW	Ezled Power	LD015D-CA07024-15	16-24 VDC 30-700mA	Triac	cULus	5	5-8
	PS-CC-12-650mA-9W-HW	Ezled Power	LD-C23510	3-12 VDC 650mA	N/D	CE	3	1-3
	PS-CC-24-650mA-9W-HW	Ezled Power	LD-C27012	3-12 VDC 650mA	N/D	CE	3	1-3
Transformateur ampérage constant 350mA AC/DC - DC/DC								
1W	PS-CC-120-350mA-8W-HW	Ezled Power	LD-CU3536AF	3-36 VDC 350mA	N/D	cULus	8	1-5
	PS-CC-120-350mA-16W-HW	Ezled Power	LD018H-CU3554-15	10-54 VDC 350mA	N/D	cULus	16	3-12
	PS-CC-120-350mA-12W-DIMA-EN	Ezled Power	LD-CU3536-04D	3-36 VDC 0-350mA	0-10V	cULus	12	1-6
	PS-CC-120-350mA-16W-DIMB-HW	Ezled Power	LD015D-CA03548-15	30-48 VDC 350mA	Triac	cULus	16	9-15
	PS-CC-12-350mA-2W-HW	Ezled Power	LD-C13510	3-10 VDC 350mA	N/D	CE	2	1-2
	PS-CC-24-350mA-2W-HW	Ezled Power	LD-C17012	3-8 VDC 350mA	N/D	CE	2	1-2

- DIMA = transformateur + gradateur 0-10V (requiert un gradateur mural)*
- DIMB = transformateur + peut être gradateur avec un triac standard.
 - En 700MA : min load : 16-24 VDC = 5 à 8 LED
 - En 350MA : min load : 30-48 VDC = 9 à 15 LED



Accessoires de branchement

- Plusieurs rallonges disponible :

- 25 CM (9.84 po) ;
- 50 CM (19.69 po) ;
- 100 CM (39.37po) ;
- 300 CM (118.11po) ;



- EZ kit 1 / 2 / 3 ;
- EZ kit fuse ;
- Pudz 3 / Pudz 6.

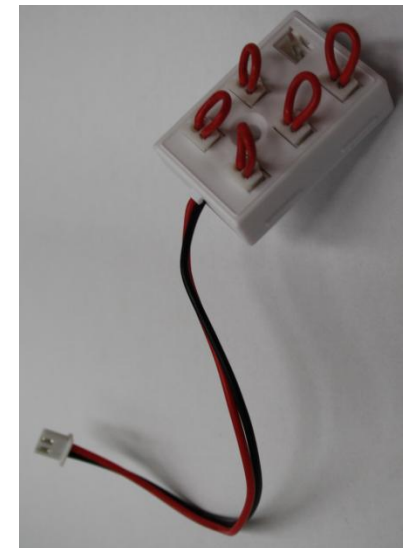
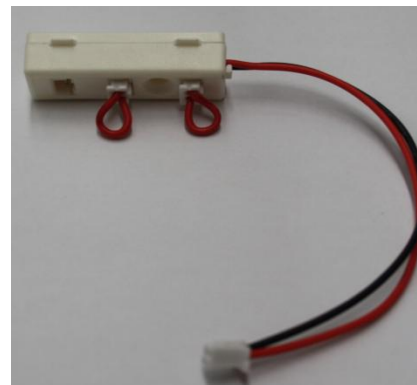

Comment brancher du 12VDC / 24VDC sur les encastrés / ampoules

- Ex : 10 X MR16 - 4W ;
- $10 \times 4 = 40W / 0.85\% = 47.06 W$;
- Le transformateur le plus proche = 75W

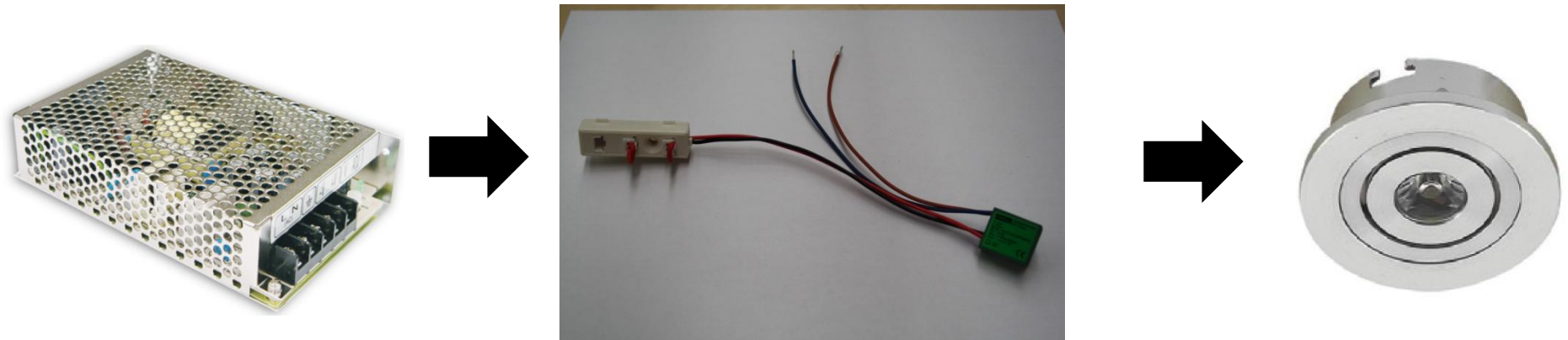

Model name	Brand/Marque	Item number	Secondaire-Output	Dim	Certif	Coutant	Base	Affiché
Transformateur ampérage constant 700mA AC/DC - DC/DC								
PS-CC-12-650mA-9W-HW	Ezled Power	LD-C23510	3-12 VDC 650mA	N/D	CE	\$5,56	\$6,95	\$9,04
PS-CC-24-650mA-9W-HW	Ezled Power	LD-C27012	3-12 VDC 650mA	N/D	CE	\$5,56	\$6,95	\$9,04
Transformateur ampérage constant 350mA AC/DC - DC/DC								
PS-CC-12-350mA-2W-HW	Ezled Power	LD-C13510	3-10 VDC 350mA	N/D	CE	\$5,56	\$6,95	\$9,04
PS-CC-24-350mA-2W-HW	Ezled Power	LD-C17012	3-8 VDC 350mA	N/D	CE	\$5,56	\$6,95	\$9,04

Produit Haute gamme ?



Éclairage murale CPV série



CREE

PW101S

Couleur	Blanc chaud / froid
Couleur de la température	3000K / 6000K
Nombre DEL	1 LED
Angle de vision DEL	1 Côté
Wattage (W)	1W
Flux lumineux (Lm)	105 Lm
Efficacité (Lm /W)	35 Lm/W
Voltage	3V
Courant électrique (mA)	350 mA



CREE

PW102S

Couleur	Blanc chaud / froid
Couleur de la température	3000K / 6000K
Nombre DEL	1 LED
Angle de vision DEL	2 Côtés
Wattage (W)	1W
Flux lumineux (Lm)	105 Lm
Efficacité (Lm /W)	35 Lm/W
Voltage	3V
Courant électrique (mA)	350 mA



PW201

Couleur	Blanc chaud / froid
Couleur de la température	3000K / 6000K
Nombre DEL	1 LED
Angle de vision DEL	1 Côté
Wattage (W)	1W
Flux lumineux (Lm)	105 Lm
Efficacité (Lm /W)	35 Lm/W
Voltage	3V
Courant électrique (mA)	350 mA



CREE

PW101R

Couleur	Blanc chaud / froid
Couleur de la température	3000K / 6000K
Nombre DEL	1 LED
Angle de vision DEL	1 Côté
Wattage (W)	1W
Flux lumineux (Lm)	105 Lm
Efficacité (Lm /W)	35 Lm/W
Voltage	3V
Courant électrique (mA)	350 mA



CREE

PW102R

Couleur	Blanc chaud / froid
Couleur de la température	3000K / 6000K
Nombre DEL	1 LED
Angle de vision DEL	2 Côtés
Wattage (W)	1W
Flux lumineux (Lm)	105 Lm
Efficacité (Lm /W)	35 Lm/W
Voltage	3V
Courant électrique (mA)	350 mA

Éclairage de surface



CREE

PL301FL3W

Couleur	Blanc chaud / froid
Couleur de la température	3000K / 6000K
Nombre DEL	1 LED
Angle de vision DEL	120°
Wattage (W)	3W
Flux lumineux (Lm)	105 Lm
Efficacité (Lm /W)	35Lm/w
Voltage	3V
Courant électrique (mA)	700 mA



CREE

PL303FL3W

Couleur	Blanc chaud / froid
Couleur de la température	3000K / 6000K
Nombre DEL	1 LED
Angle de vision DEL	120°
Wattage (W)	3W
Flux lumineux (Lm)	105 Lm
Efficacité (Lm /W)	35Lm/w
Voltage	3V
Courant électrique (mA)	700 mA



CREE

PL302SP3W

Couleur	Blanc chaud / froid
Couleur de la température	3000K / 6000K
Nombre DEL	1 LED
Angle de vision DEL	30°
Wattage (W)	3W
Flux lumineux (Lm)	105 Lm
Efficacité (Lm /W)	35Lm/w
Voltage	3V
Courant électrique (mA)	700 mA



CREE

PL304S03W

Couleur	Blanc chaud / froid / RGB
Couleur de la température	3000K / 6000K
Nombre DEL	1 LED
Angle de vision DEL	30°
Wattage (W)	3W
Flux lumineux (Lm)	105 Lm
Efficacité (Lm /W)	35Lm/w
Voltage	3V
Courant électrique (mA)	700 mA

Encastrés PL107



XSPOT SPOT FLOOD

120V

CW Cold White
Blanc Froid

WW Warm White
Blanc Chaud



Couleur de finition disponible :
Aluminium / Blanc / noir

Transformateur 350 Ma, externe inclus

PL107

	3W	5W	7W	9W
Couleur	Blanc chaud / froid	Blanc chaud / froid	Blanc chaud / froid	Blanc chaud / froid
Couleur de la température	3000K / 6000K	3000K / 6000K	3000K / 6000K	3000K / 6000K
Nombre DEL	3 LED	5 LED	7 LED	9LED
Angle de vision DEL	15° 30° 60°	15° 30° 60°	15° 30° 60°	15° 30° 60°
Wattage (W)	3W	5W	7W	9W
Flux lumineux (Lm)	(BC) (BF) 162 Lm 216 Lm	220 Lm 360 Lm	378 Lm 504 Lm	486 Lm 648 Lm
Efficacité (Lm /W)				
Voltage	3V	3V	3V	3V
Courant électrique (mA)	350 mA	350 mA	350 mA	350 mA

Modules



MOD-T2-1-IP65

Couleur	Blanc chaud / froid
3 températures de blanc disponible	3200K / 4200K / 5600K <i>Sur commande: 2400 à 6000K</i>
Niveaux de protection	IP65
Nombre DEL	2 LED
Angle de vision DEL	120°
Wattage (W)	1 W
Flux lumineux (Lm)	40 Lm
Voltage	12V
Efficacité (Lm /W)	40 Lm/W



MOD-T3-RGB-IP65

Couleur	RGB (Rouge, vert, bleu)
Niveaux de protection	IP65
Nombre DEL	3 LED
Angle de vision DEL	120°
Wattage (W)	0.6W
Flux lumineux (Lm)	R: 3,66Lm G: 1,75Lm B: 0.6Lm
Voltage	12V

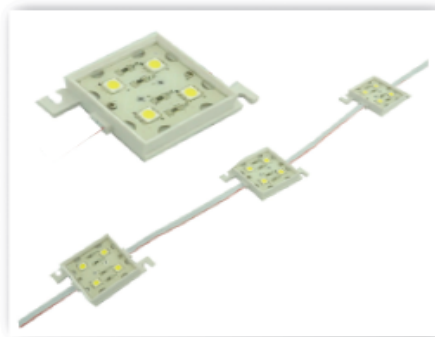

MOD-T4-2-IP65

Couleur	Blanc chaud / froid
3 températures de blanc disponible	3200K / 4200K / 5600K <i>Sur commande: 2400 à 6000K</i>
Niveaux de protection	IP65
Nombre DEL	4 LED
Angle de vision DEL	120°
Wattage (W)	2W
Flux lumineux (Lm)	80Lm
Voltage	12V
Efficacité (Lm /W)	40 Lm/W

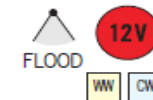

Barres ALBH



ALBH25

Couleur Blanc chaud / froid,
RGB (Rouge, Vert, Bleu)

Niveaux de protections 5mm

Nombre DEL 25 LED / 5mm

Wattage (W) 2 W

Flux lumineux (Lm) 80 Lm

Voltage 12V

Dessin technique

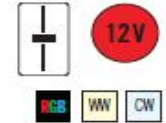
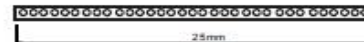

ALBH54

Couleur Blanc chaud / froid,
RGB (Rouge, Vert, Bleu)

Niveaux de protections 5mm

Nombre DEL 54 LED

Wattage (W) 4 W

Flux lumineux (Lm) 160 Lm

Voltage 12V

Dessin Technique

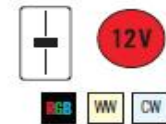

ALBH105

Couleur Blanc chaud / froid,
RGB (Rouge, Vert, Bleu)

Niveaux de protections 5mm

Nombre DEL 105 LED

Wattage (W) 8 W

Flux lumineux (Lm) 320 Lm

Voltage 12V

Dessin technique

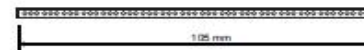



Lux LINE

PAR **Lum⁺nergie**



120V AC

Modèle	T° de couleur	Voltage	Puissance	Lumen	Faisceau	Éclairage	CRI
		(V)	(W)	(Lm)	(°)	(Lux-1m)	
LUXL-03W/03C	3000°K / 6500°K	AC 95-245V	5W	220	100°/ 55°	200Lux / 90Lux	70
LUXL-06W/06C	3000°K / 6500°K	AC 95-245V	10W	440	100°/ 55°	380Lux / 170Lux	70
LUXL-09W/09C	3000°K / 6500°K	AC 95-245V	14W	660	100°/ 55°	480Lux / 220Lux	70
LUXL-12W/12C	3000°K / 6500°K	AC 95-245V	19W	880	100°/ 55°	550Lux / 270Lux	70

Lux LINE

PAR **Lum**nergie

- Connexion AC directe avec transformateur intégré dans le luminaire.
- Installation simple avec plaquettes de montage aux deux extrémités.
- Branché en série, LUX LINE peut être connecté à plus de 350w.
- Interconnexion sans espacements.
- Disponible en faisceau 100° et 55°
- Rotation 180°

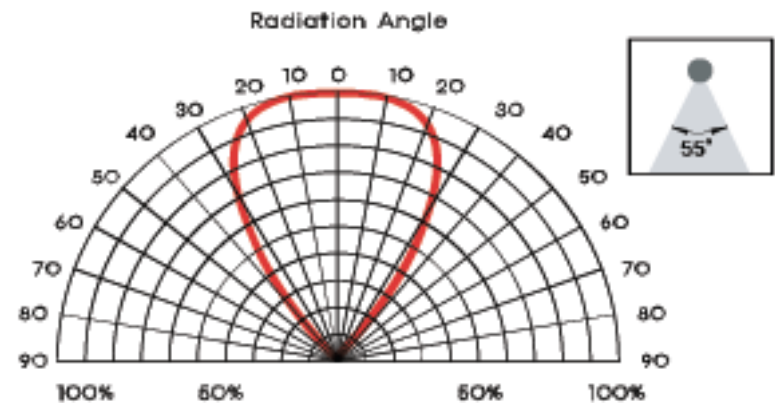
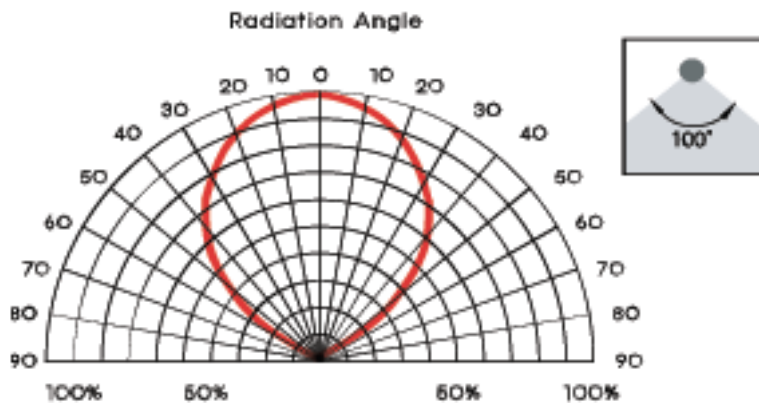

Lux LINE

BY Lumenergy



A.LB21, 3.3 W/ft
220 lm **Epi-star**

Ultra thin heat-sink



A LB21, 3.3W/ft, Epi-star

Model	LED	LED #	Watts	CCT	Lumens	Beam Angle (@50% CBCP)	CRI	Length	Voltage
LB21-DW-L05 LB21-NW-L05 LB21-WW-L05	Epi-star chip	2-Leds	0.5W	5000~6300K 3700~4300K 2600~3000K	55 lm 55 lm 48 lm	120°	70 65 65	5 cm	24 V DC
LB21-DW-L15 LB21-NW-L15 LB21-WW-L15 LB21-XW-L15	Epi-star chip	6-Leds	1.65W	5000~6300K 3700~4300K 2600~3000K 2300~2600K	110 lm 110 lm 95 lm 80 lm	120°	70 65 65 60	15 cm	24 V DC
LB21-DW-L30 LB21-NW-L30 LB21-WW-L30 LB21-XW-L30	Epi-star chip	12-Leds	3.3W	5000~6300K 3700~4300K 2600~3000K 2300~2600K	220 lm 220 lm 190 lm 160 lm	120°	70 65 65 60	30 cm	24 V DC
LB21-DW-L60 LB21-NW-L60 LB21-WW-L60 LB21-XW-L60	Epi-star chip	24-Leds	6.6W	5000~6300K 3700~4300K 2600~3000K 2300~2600K	440 lm 440 lm 380 lm 320 lm	120°	70 65 65 60	60 cm	24 V DC
LB21-DW-L90 LB21-NW-L90 LB21-WW-L90 LB21-XW-L90	Epi-star chip	36-Leds	9.9W	5000~6300K 3700~4300K 2600~3000K 2300~2600K	660 lm 660 lm 570 lm 540 lm	120°	70 65 65 60	90 cm	24 V DC
LB21-DW-L120 LB21-NW-L120 LB21-WW-L120 LB21-XW-L120	Epi-star chip	48-Leds	13.2W	5000~6300K 3700~4300K 2600~3000K 2300~2600K	880 lm 880 lm 720 lm 640 lm	120°	70 65 65 60	120 cm	24 V DC

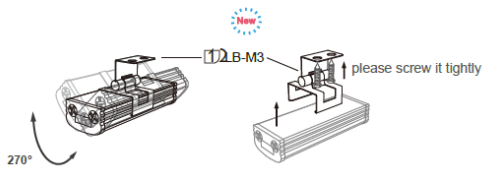

DDC 4000

4 channels dimmer

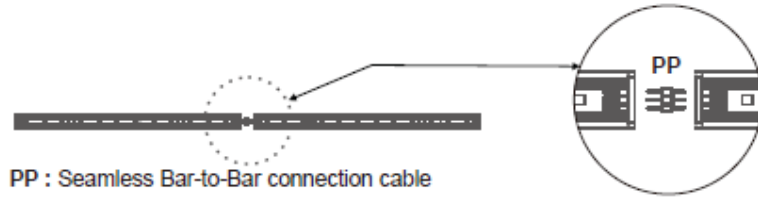

PP : Seamless Bar-to-Bar connection cable

Single (30cm)



Max.40W per channel

- 2pcs for LB21
- 8pcs for LB31
- 2pcs for LB2C
- 20pcs for LB1C

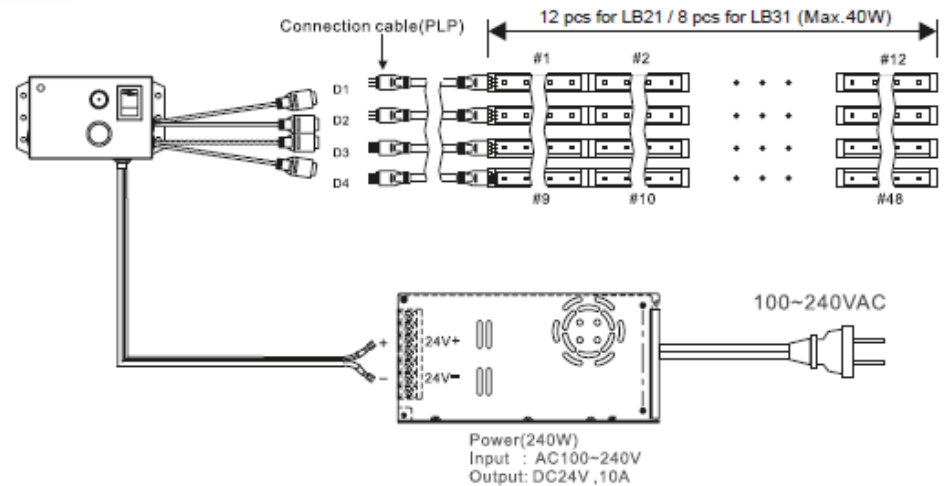
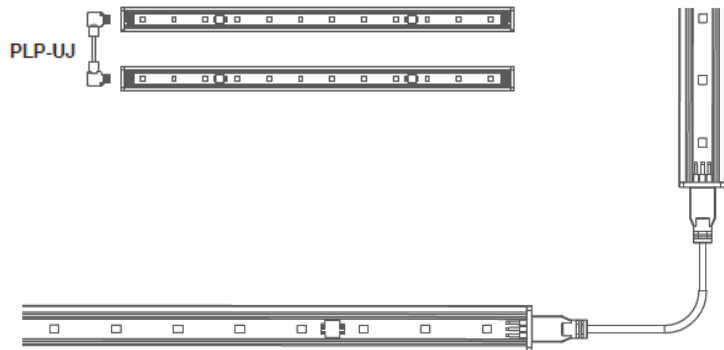
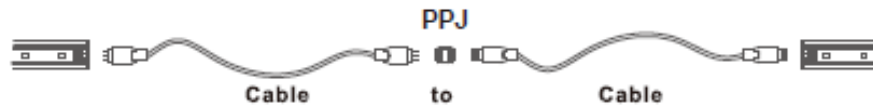



1 PP

Model No. : LB-PP
Description:
 LuxLine seamless type connector

2 PLP/PLP02

Model No. : LB-PLP-LXX
 LB-PLP02-LXX
Description:
 connection cable between LuxLine bars
 * PLP02 : locking type
Length :
 25/50/100/150/183cm

3 PLP-UJ

Model No. : LB-PLP-UJ
Description:
 U-shape jumper between LuxLine bars
Length : 5cm

4 PPJ

Model No. : LB-PPJ
Description:
 cable-to-cable extension joint

5 MCJ

Model No. : LB-MCJ
Description:
 Multiple cable-to-cable extension joint

Power Line (Bar-to-adaptor/power)



6 PL/PL02

Model No. : LB-PL-LXX
 LB-PL02-LXX
Description:
 Power line connection cable
 * PL02 : locking type
Length : 30/50/100cm

7 PL-RA

Model No. : LB-PL-LXXRA
Description:
 Power line connection cable (Right Angel pin)
Length : 50/183cm

8 PL-SW

Model No. : PL-LXXSW
 PL-LXXRASW
Description:
 Power line connection cable (Power line with inline switch)
Length : 30/183cm

9 PL-W/PL02-W

Model No. : LB-PL-LXXW
 LB-PL02-LXXW
Description:
 Bar-to-power connection wire (With 2-wire out)
 * PL02-W : locking type
Length : 50cm

10 PL-BA

Model No. : LB-BA
Description:
 Power Line connection cable (back side cable o

Mounting Clip



11 LB-M1

Model No. : LB-M1
Description:
 Flat type mounting clip (including screw)

12 LB-M2

Model No. : LB-M2
Description:
 45 degree type mounting clip (including screw)

13 LB-M3

Model No. : LB-M3
Description:
 Turnable mounting Clip (including screw)

4 Other



14 LB-BBC

Model No. : LB-BBC
Description:
 Bar-to-bar back Clip to lock two bars seamless together (with LB-PP)

Encastrés de sol

- IP67 ;
- LED: 1 x 3W - 45° ;
- Finition en stainless steel ;
- Vitre de 12mm d'épaisseur ;
- Consommation: 3.7W ;
- Voltage: 12 / 24 VDC ;
- Disponible en blanc chaud, blanc froid et RGB.

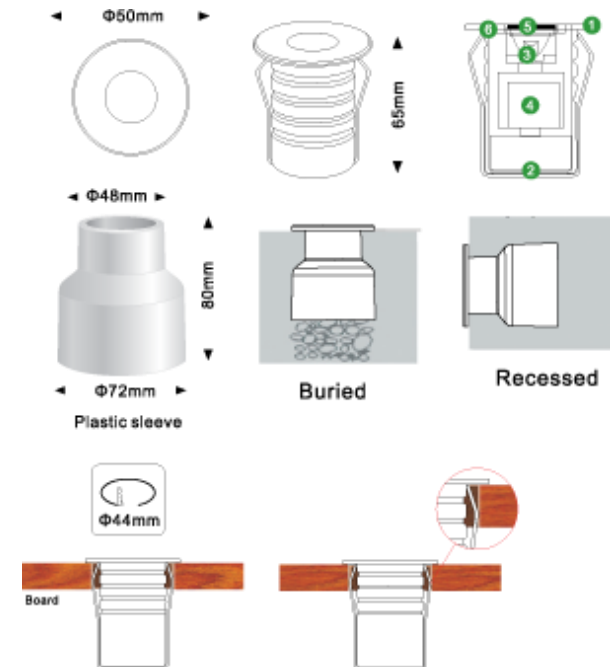

Lampes

Model No.	Mode	Color Temp.	Illuminance, Lux
Q-200	Science	6500~7000K	1400
	Memory	3800~4500K	1400
	Resting	2500~3000K	800



Prix spéciaux

Achetez ces lampes maintenant et ne payez que



Aujourd'hui seulement

Rég : 124.99\$

Projecteur RGB 36W

- Dimensions : Largeur : 334mm Profondeur : 152mm Hauteur : 214mm ;
- Angle de rotation 150° ;
- Courant en entrée 100-256V AC vertical - 60° horizontal ;
- Température utilisation -30°C à 40°C ;
- IP65 ;
- Faisceaux disponibles pour DEL : 15°, 30° et 45° ;
- Mode de fonctionnement :
 - 1) Mode indépendant ;
 - 2) Mode DMX 512 ;
 - 3) Mode maître/esclave.



Comment installer un gradateur sur du ruban

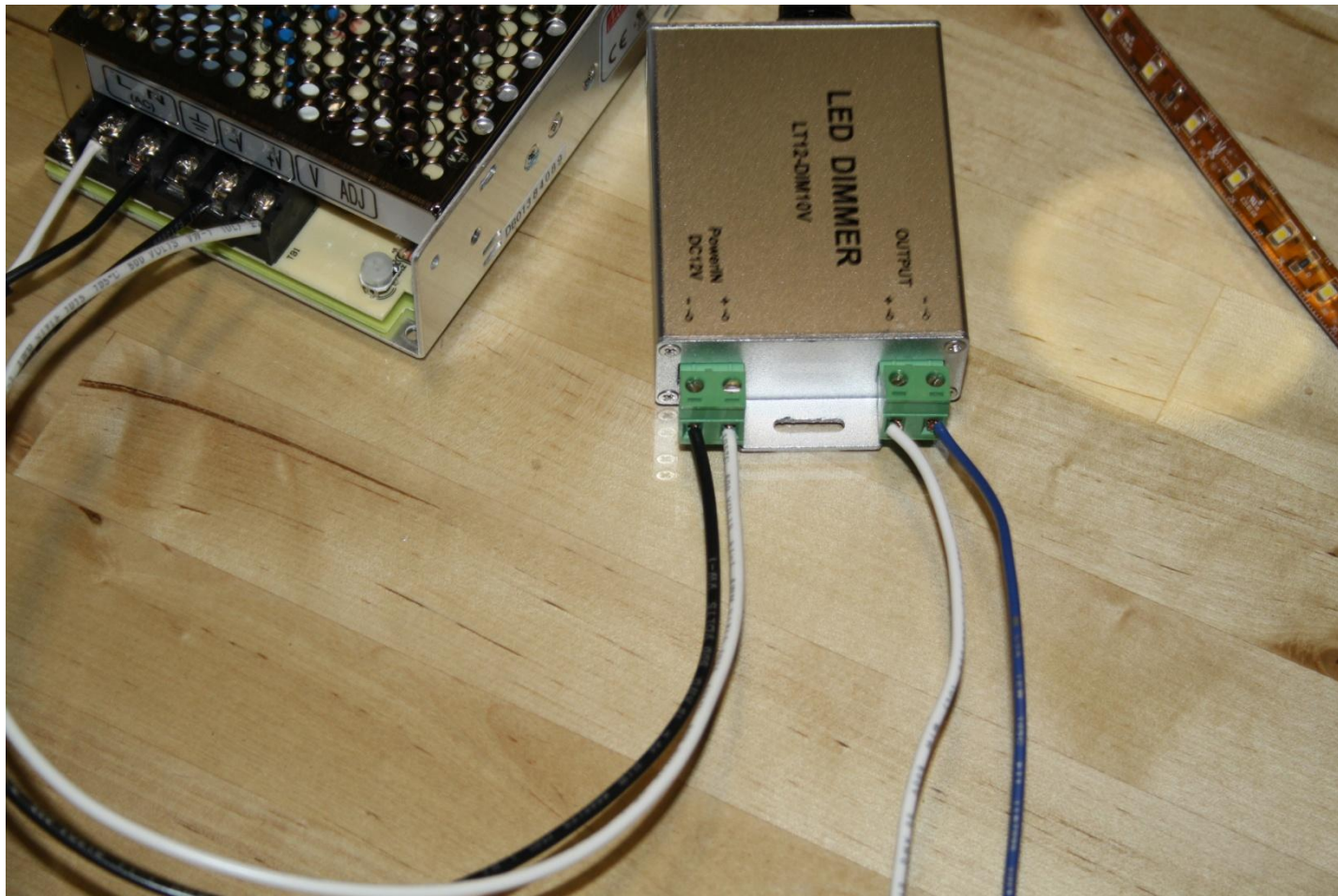

Comment installer un repeater ST-3060

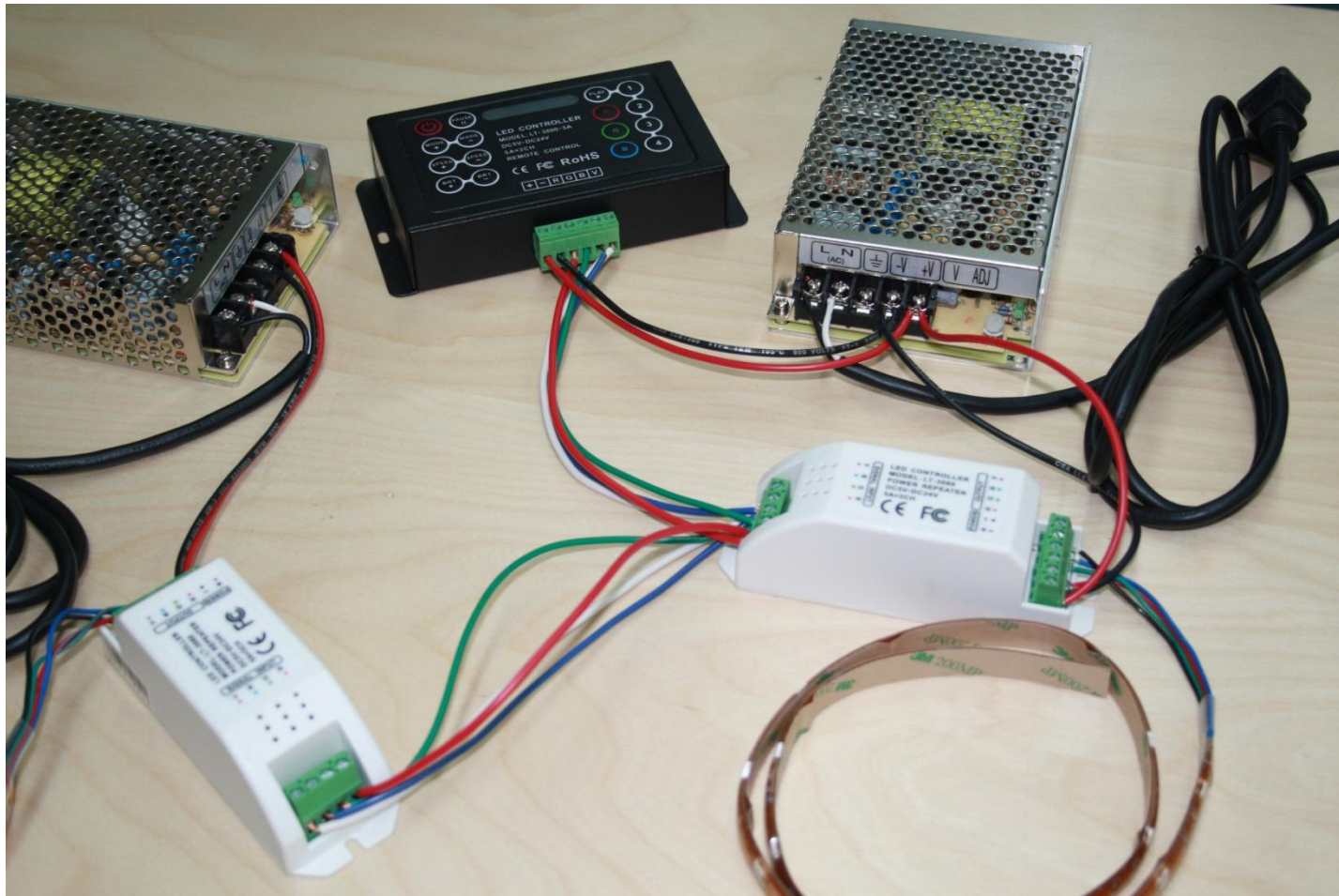

Comment installer un gradateur murale



Comment installer un gradateur 0-10V

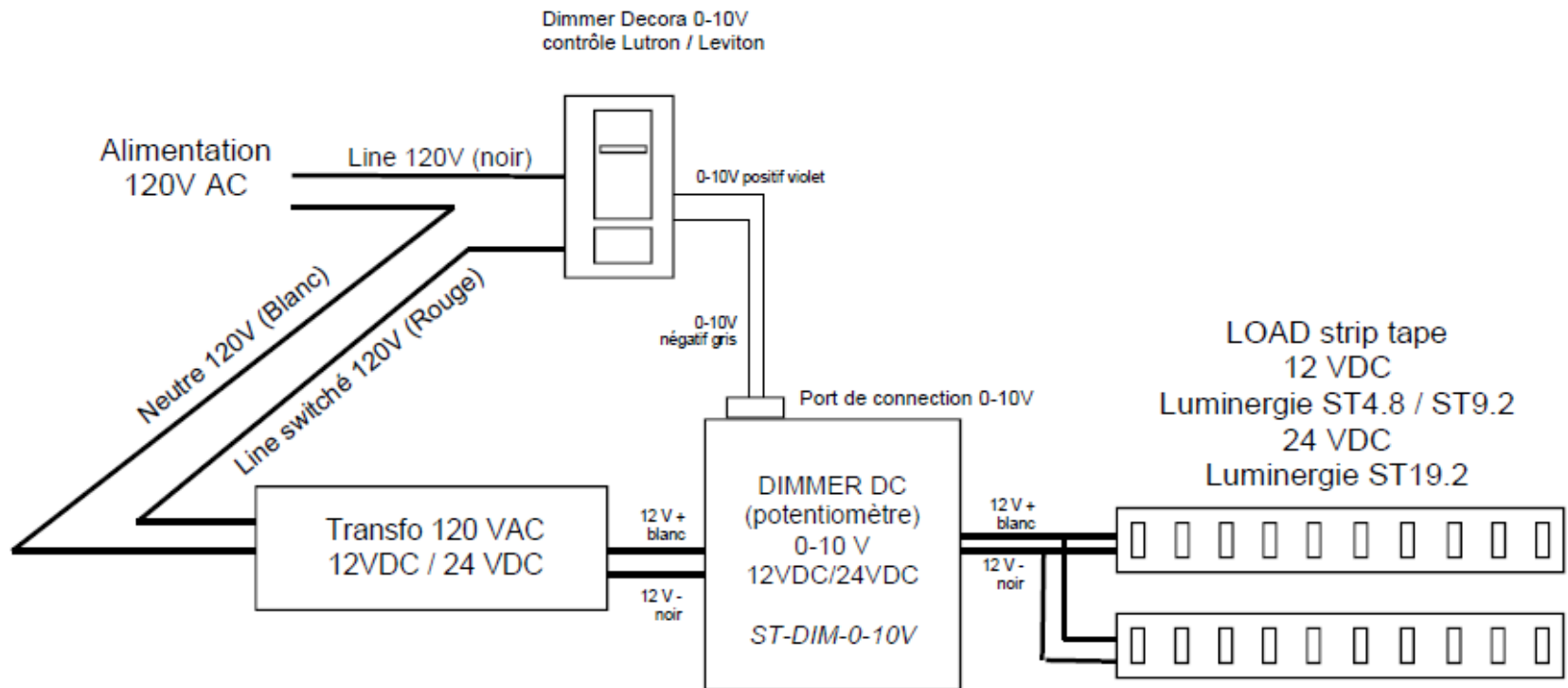



**Luminergie vous remercie pour
votre temps et votre énergie.**

Tout les documents sont disponible à :

www.luminergie.com

<http://montreal.luminergie.com>